

# The Craftsman

COLLECTION

Quality Handcrafted in Pennsylvania, USA



# Table of CONTENTS

04

MISSION

28

CLASSIC MISSION

34

PANEL MISSION

40

SHAKER

46

BREEZY POINT

54

DESIGN GALLERY

For more than 30 years we have been designing and building furniture for the Craftsman Collection brand. Currently we employ the fourth generation of family woodworkers.

Every piece of furniture is produced with sustainably-harvested American hardwoods which means that every tree that is cut down has a replacement sapling that is growing, sequestering carbon, and releasing oxygen. Instead of deforesting, our lumbermen are pruning and refining our wonderful resource, the forest.

During the last 15 years we have added a large variety of motion and upholstered furniture. Today we are happy to say that 100% of our steel mechanisms are designed and manufactured in America. The foam cushions are carefully upholstered in our own shops by highly skilled seamstresses and upholsterers.

For maximum control of quality our furniture is stained and coated with a conversion varnish in our own finishing facility. The finish products have been tested extensively and we are confident that they will preserve the wooden surface of your furniture for years.

With passion for good furniture and skilled craftsmen we feel confident that your furniture is built to last. That's the reason we offer our industry leading warranties.





MISSION

## MISSION OPTIONS

- Quarter-Sawn White Oak
  - Brown Maple
  - Red Oak
  - Cherry
- 
- Fabric
- Faux Leathers
- Genuine Leather

## MISSION FEATURES

- Handmade in America
- Durable Cushions
- Dovetail Drawer Boxes
- Full Extension Drawer Slides

*and*  
*comfort*  
*of course!*

As the Spanish swept across the southwest corner of North America they built furniture out of necessity. Today their simple style still resonates with seekers of simplicity and functional beauty. The sturdy lines of this revival style paired with the finest of American hardwoods complements the craftsmanship and comfort of Craftsman Collection Mission.

## COFFEE TABLES & SOFA SERVERS

all pieces shown in oak with harvest stain



#01  
**JR. COFFEE TABLE**  
42"w x 18"d x 19"h



#04  
**SQUARE COFFEE TABLE**  
34"w x 34"d x 19"h



#03  
**COFFEE TABLE WITH DRAWER**  
50"w x 24"d x 19"h



#13  
**LIFT TOP COFFEE TABLE**  
50" w x 24" d x 19" h



Shown in raised position (29").  
Features smooth acting lift mechanism  
made in the USA.



#79  
**SOFA SERVER**  
14" w x 16" d x 24" h



#77  
**LARGE SOFA SERVER**  
20" w x 16" d x 27" h

# MISSION

# MISSION END TABLES

all pieces shown in oak with harvest stain



#02  
**JR. END TABLE**  
22"w x 16"d x 25"h



#48  
**ROUND END TABLE**  
22" x 22"h

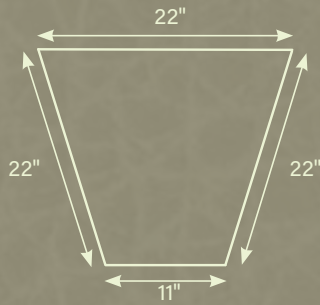

#11  
**WEDGE TABLE**  
22"w x 22"d x 25"h



#72  
**END TABLE**  
20"w x 23"d x 25"h



#06  
**CHAIR-SIDE TABLE**  
16"w x 22"d x 25"h



#07  
END TABLE WITH DRAWER  
24"w x 24"d x 25"h



#05  
SQUARE END TABLE  
24"w x 24"d x 25"h



# MISSION

# SOFA TABLES & HALL FURNITURE

all pieces shown in oak with harvest stain

#98  
**2 DRAWER SOFA TABLE**  
50"w x 16"d x 30"h



#70  
**HALL TABLE**  
27"w x 14"d x 30"h



#99  
**SOFA TABLE**  
64"w x 16"d x 30"h



#20  
**STORAGE BENCH**  
42"w x 11"d x 19"h



#32  
**DEACON'S BENCH WITH STORAGE**  
47"w x 22"d x 45"h



#78  
**CLOTHES TREE**  
16"w x 16"d x 68"h

# MISSION

## ENTERTAINMENT

all pieces shown in oak with harvest stain



#90  
TV/VCR CABINET  
35" w x 19" d x 30" h  
with adjustable shelves



#91  
ENTERTAINMENT CENTER  
50" w x 19" d x 30" h



#93  
ENTERTAINMENT CENTER  
50" w x 19" d x 30" h  
with adjustable shelves



#68  
**FUTON**  
 86" w x 37" d x 38" h



Back View



**FUTON IN BED POSITION**  
 86" w x 54" d 25" h  
**MATTRESS**  
 54" w x 76" d 10" h

**MATTRESS OPTIONS**

Our futon mattresses are 9" thick and constructed of high quality foam and cotton. The mattress comes with a standard sage micro-fiber cover but is available in any of the colors below. The mattress can also be fitted with a fabric cover as seen in the pictures above. See page 57 for more fabric options

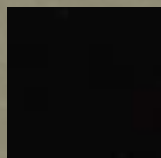

black



blue



chocolate



sage



tan

MISSION



#85  
**MISSION LOVESEAT**  
60" w x 35" d x 37" h\*



#87  
**OTTOMAN**  
23" w x 16" d x 15" h



#86  
**SOFA**  
86" w x 35" d x 37" h\*  
shown in 10-11 Myth fabric



Back View

#84  
**MORRIS CHAIR**  
34" w x 35" d x 37" h\*  
Shown in cherry wood with  
natural finish and rum leather.



Morris chairs feature an 8 position recline.



Based on a design found in a small cabinetry shop in Sussex, England, the Morris Chair was developed and first sold by Morris and Company around 1866. Through the influence of Gustav Stickley and the American Arts and Crafts movement, the American Morris chair took on an unsophisticated air of sturdy reliability.

Our rendition of this faithful old chair features an eight position recline, gently curved armrests, and the same legacy of durable comfort.

# MISSION



#62  
**RECLINER LOVESEAT**  
58"w x 35"d x 42"h\*



#63  
**RECLINER SOFA**  
82"w x 35"d x 42"h\*  
**shown in 16-52 Reap fabric**



Padded Armrest Upgrade



#61  
**RECLINER**  
34"w x 35"d x 42"h\*  
shown in whiskey leather



Bustle Back Upgrade

From the legs to the last detail of the upholstery we take extra pleasure in creating exceptional recliners. The easy push-back mechanism is made in America and is built to handle all the wear that a comfortable recliner is prone to get. Each section of the loveseat and sofa recliners reclines independently.

Powered recliner features finger touch controls conveniently concealed in the seat.

The Bustle Back upgrade option gives the recliner a soft cushion feel without losing its beauty.

# MISSION



#55  
**ROCKER**  
29"w x 36"d x 41"h\*



#53  
**SWIVEL GLIDER**  
31"w x 32"d x 42"h\*

#54  
**GLIDER OTTOMAN**  
23"w x 16"d x 15"h



#56  
**LIBRARY CHAIR**  
29"w x 27"d x 43"h\*



#52  
**GLIDER**  
31"w x 32"d x 42"h\*



Semi-Recline Position



#65  
**SWIVEL GLIDER RECLINER**  
31" w x 35" d x 41" h\*  
shown in cobblestone leather



Bustle Back Upgrade

We're serious about comfort. If you don't believe it try our swivel recliner. The mechanism is made right here in the United States. Paired with American hardwoods and premium upholstery that will resist the wear of everyday use. Add the bustle back upgrade for the next level of comfort!

# MISSION

# Wall-Hugger

*modular recliner system*



When we set out to create a Wall-Hugger recliner we approached it with a no-holds barred attitude. This resulted in a system that is not only a wall-hugger but also totally modular, letting you create custom configurations that fit your needs.

The left/right unit, armless units, and corner units connect securely using our special coupling system. Reclining units are functional throughout the configuration (not just on the ends) and available with power recline, manual recline, and stationary mechanisms.

**AVAILABLE IN:**

#41 Mission  
#141 Classic Mission  
#241 Panel Mission  
#541 Shaker Mission  
#741 Breezy Point

Bustle Back Upgrade



#41  
**RECLINER**  
34"x35"x42"



**#41 Reclining Options:**

*Stationary (#41-STA)*  
*Manual (#41-MAN)*  
*Powered (#41-PRW)*

The Wall-Hugger recliner matches seamlessly with our Wall-Hugger sofa and sectional configurations. Available with powered or manual recline as well as bustle back upgrade. The recliner is a stand-alone unit and not interchangeable with other Wall-Hugger components but it features the same great style and functionality.

# MISSION

\*All measurements are approximate

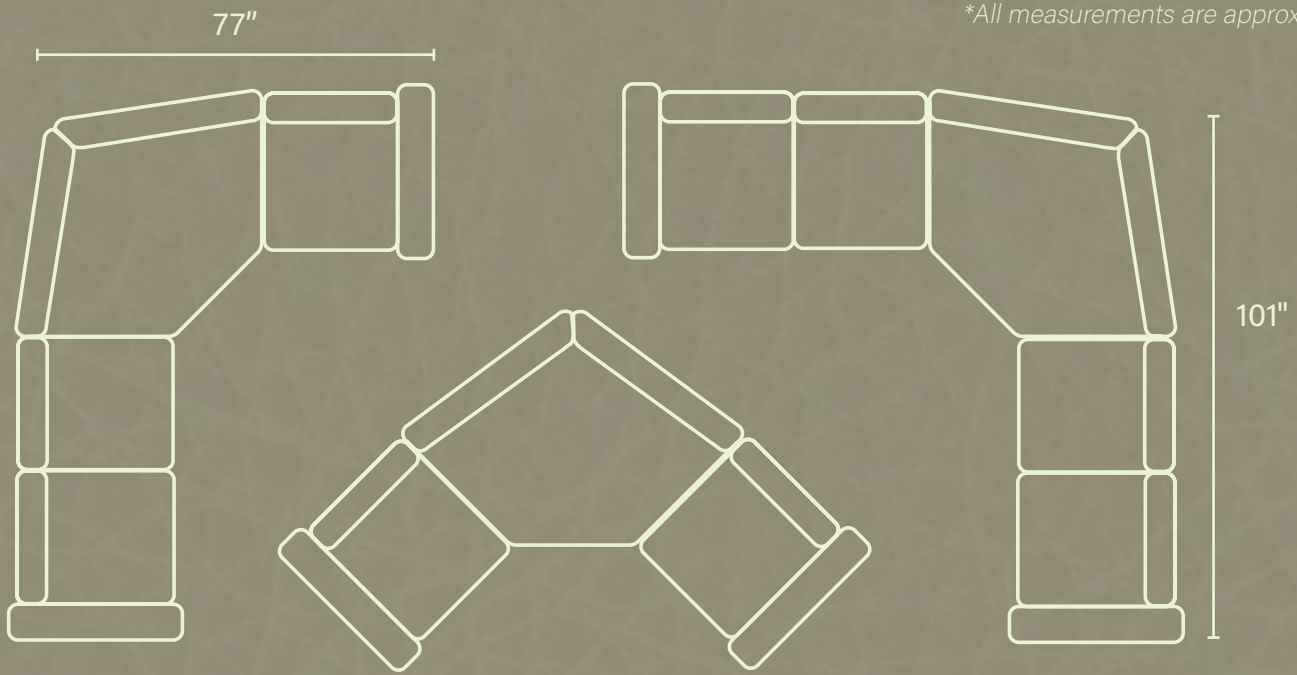

*What will you create?*

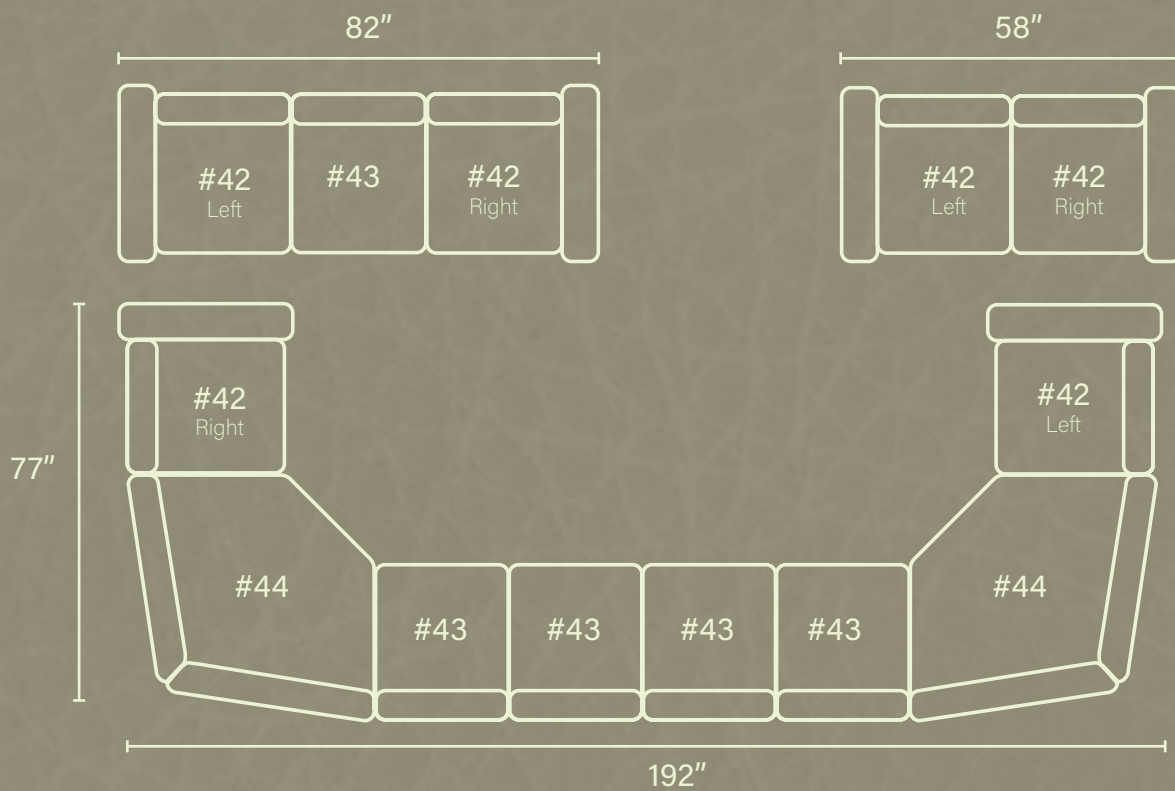

**Wall-Hugger**  
modular recliner system



#42 + #43  
**RECLINER SOFA COMBINATION**  
82"x35"x42"

**#42 & #43 Reclining Options:**

Stationary (#42-STA || #43-STA)

Manual (#42-MAN || #43-MAN)

Powered (#42-PRW || #43-PRW)

#42

**LEFT & RIGHT UNITS**

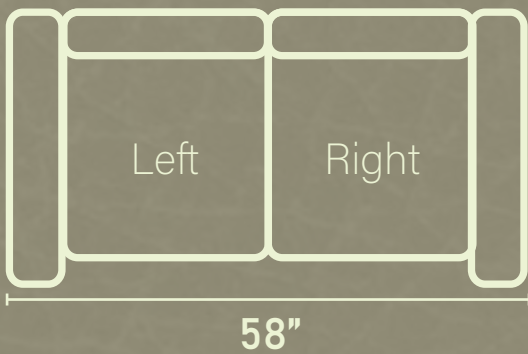

#43

**ARMLESS UNIT**



#44

**CORNER UNIT**

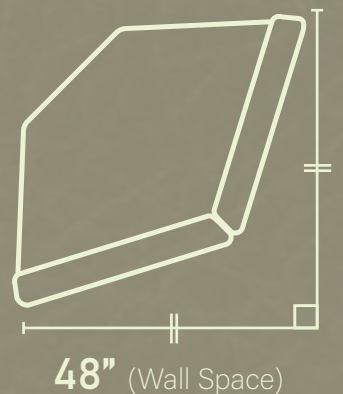

# MISSION

#58  
**16" THROW PILLOW**  
Available in leather and fabric



#59  
**20" THROW PILLOW**  
Available in leather and fabric



#81  
**CLUB LOVESEAT**  
57" w x 35" d x 30" h\*  
Shown in Oak with  
Autumn Wheat stain



#80  
**CLUB SOFA**  
78" w x 35" d x 30" h\*

\* all seats are approximately 19" high and 20" deep



#82

**CLUB CHAIR**

36" w x 35" d x 30" h\*

shown in Quarter-sawn White Oak  
with Michaels OCS 113 stain

This heritage take on the sofa is deeply rooted in mission style. The low profile makes the club a great option when you want to maintain an open feel or when placing it in front of a window. All fabric seat and back cushions come in one unit, as seen on the loveseat, unless special ordered. Leather cushions will be divided, two sections for loveseats, three sections for sofas.

# MISSION



# Santa Fe

With their clean, open silhouettes the Santa Fe occasional tables portray an exceptionally pure mission and pair well with our Classic Mission and Panel Mission upholstery.



#873  
SANTA FE COFFEE TABLE  
41" w x 19" d x 19" h\*



#877  
SANTA FE SOFA TABLE  
42" w x 16" d x 30" h\*



#876  
SANTA FE END TABLE  
18" w x 22" d x 22" h\*



#36  
**FIREPLACE**  
59" w x 14" d x 42" h\*  
with electric fireplace insert



Side View

Bring the comfortable glow of a fireplace into any room of your house without the need to vent or make permanent changes. The fireplace insert can be connected to a 110 volt wall outlet and provides electric heat and flame simulations all controlled with the handheld remote. The fireplace sides open to reveal a hidden bookshelf.

# MISSION



CLASSIC

# MISSION

## CLASSIC MISSION OPTIONS

- Quarter-Sawn White Oak
  - Brown Maple
  - Red Oak
  - Cherry

-----

- Fabric
- Faux Leathers
- Genuine Leather

## CLASSIC MISSION FEATURES

- Handmade in America
- 1" Thick Table Tops
- Durable Cushions
- Dovetail Drawer Boxes
- Full Extension Drawer Slides

*and*  
*comfort*  
*of course!*

The petite spindles of the mission style give way to the wide slats, thick tops, and heavy legs of the Classic Mission style. The durable simplicity that's written all over this style promise a stable, comforting atmosphere.



**MORE IN CLASSIC MISSION**  
Many of the items featured in pages 13 to 23 of this catalog are also available in classic mission. Here's just a few of them:

- 168 Futon
- 182 Club Chair
- 181 Club Loveseat
- 180 Club Sofa
- 154 Gliding Ottoman
- 141 Wall Hugger Recliners

#176  
**CLASSIC END TABLE**  
21"w x 25"d x 25"h



#173  
**COFFEE TABLE**  
50"w x 25"d x 19"h



Shown in quarter-sawn white oak wood with Michaels stain.

#177  
**SOFA TABLE**  
50"w x 16"d x 30"h



#155  
**ROCKER**  
29"w x 36"d x 41"h\*



#156  
**LIBRARY CHAIR**  
29"w x 27"d x 43"h\*

\* all seats are approximately 19" high and 20" deep

CLASSIC

MISSION

#161  
**RECLINER**  
34"w x 35"d x 42"h\*



#163  
**RECLINER SOFA**  
82"w x 35"d x 42"h\*

#153  
**SWIVEL GLIDER**  
31"w x 32"d x 42"h\*



#154  
**GLIDER OTTOMAN**  
23"w x 16"d x 15"h\*

\*See pages 13 to 25 for details  
on our upholstered items.

#184  
**MORRIS CHAIR**  
34"w x 35"d x 37"h\*



#187  
**OTTOMAN**  
23"w x 16"d x 15"h\*



#165  
**SWIVEL GLIDER RECLINER**  
31"w x 35"d x 41"h\*

#186  
**SOFA**  
86"w x 35"d x 37"h\*



\* all seats are approximately 19" high and 20" deep

CLASSIC

MISSION



# PANEL MISSION

## PANEL MISSION OPTIONS

- Quarter-Sawn White Oak
  - Brown Maple
  - Red Oak
  - Cherry

-----

- Fabric
- Faux Leathers
- Genuine Leather

## PANEL MISSION FEATURES

- Handmade in America
- Rail & Stile Panels
- Durable Cushions
- Dovetail Drawer Boxes
- Full Extension Drawer Slides

*and*  
*comfort*  
*of course!*

Elegant with a slightly aristocratic air Panel Mission is a refined mission style that displays the finest in American craftsmanship. The rail & stile side panel is a technique that the early masters, though they may not have used it, would surely have been proud of.



#261  
**RECLINER**  
34"w x 35"d x 42"h\*



#242 + #43  
**RECLINER SOFA COMBINATION**  
82"w x 35"d x 42"h

\*features Wall-Hugger recliner mechanisms  
see page 20 for more details



#276  
**END TABLE**  
21"w x 25"d x 25"h



#287  
**OTTOMAN**  
23"w x 16"d x 15"h

#284  
**MORRIS CHAIR**  
34"w x 35"d x 37"h\*



#263  
**RECLINER SOFA**  
82"w x 35"d x 42"h\*

PANEL  
MISSION

**MORE IN PANEL MISSION**

Many of the items featured in pages 13 to 23 of this catalog are also available in panel mission. Here's just a few of them:

- 268 Futon
- 261 Recliner
- 254 Gliding Ottoman
- 256 Library Chair
- 241 Wall Hugger Recliners



#253  
**SWIVEL GLIDER**  
31"w x 32"d x 42"h\*



#285  
**LOVESEAT**  
60"w x 35"d x 37"h\*



#280  
**CLUB SOFA**  
78"w x 35"d x 30"h\*

\* all seats are approximately 19" high and 20" deep



#255  
**ROCKER**  
29"w x 36"d x 41"h\*



#286  
**SOFA**  
86"w x 35"d x 37"h\*



#265  
**SWIVEL GLIDER RECLINER**  
31"w x 35"d x 41"h\*

PANEL  
MISSION



shaker

## SHAKER OPTIONS

- Quarter-Sawn White Oak
  - Brown Maple
  - Red Oak
  - Cherry
- 
- Fabric
- Faux Leathers
- Genuine Leather

## SHAKER FEATURES

- Handmade in America
  - Rail & Stile Panels
  - Durable Cushions
- Dovetail Drawer Boxes
- Full Extension Drawer Slides

*and*  
*comfort*  
*of course!*

First designed by a religious sect nicknamed the Shakers this style has a petite feel thanks to the signature tapering of the legs. Like the Spanish before them the Shakers embraced simplicity and utility, values that we work hard to build into our Shaker style.



#573  
COFFEE TABLE WITH DRAWER  
42" w x 18" d x 19" h



#509  
PETITE SOFA TABLE  
38" w x 12" d x 30" h



#578  
WRITING DESK  
48" w x 22" d x 30" h



#577  
SOFA TABLE WITH DRAWER  
42" w x 14" d x 30" h



#513  
COFFEE TABLE WITH LIFT TOP  
44"w x 22"d x 19"h (29" raised)



#576  
END TABLE WITH DRAWER  
18"w x 24"d x 25"h



#501  
PETITE COFFEE TABLE  
38"w x 16"d x 17"h



#502  
PETITE END TABLE  
16"w x 22"d x 22"h

shaker

**MORE IN SHAKER**

Many of the items featured in pages 13 to 23 of this catalog are also available in Shaker.

Here's just a few of them:

- 568 Futon
- 561 Recliner
- 586 Sofa
- 565 Swivel Recliner
- 554 Gliding Ottoman
- 556 Library Chair
- 541 Wall Hugger Recliners



#555  
**ROCKER**  
29"w x 36"d x 41"h\*



#563  
**RECLINING SOFA**  
82"w x 35"d x 42"h\*



#562  
**RECLINING LOVESEAT**  
58" w x 35" d x 42" h\*



#553  
**SWIVEL GLIDER**  
31" w x 32" d x 42" h\*



#584  
**MORRIS CHAIR**  
32" w x 35" d x 37" h\*

#587  
**OTTOMAN**  
23" w x 16" d x 15" h

shaker



*Breezy*  
- Point -

## BREEZY POINT OPTIONS

- Brown Maple
  - Red Oak
  - Cherry
- 
- Fabric
- Faux Leathers
- Genuine Leather

## BREEZY POINT FEATURES

- Handmade in America
  - Durable Cushions
  - Dovetail Drawer Boxes
- Full Extension Drawer Slides
- Flared Feet and Gentle Curves

*and*  
*comfort*  
*of course!*

Sea vibes come naturally with this nautical mission style. It's as if the Spanish sea captains asked for their own twist to Spanish Revival mission. Right at home in your oceanfront cottage but an equally excellent way to bring a bit of the seashore right into your home. The sea is calling, who can resist...

#772  
END TABLE  
19"w x 22"d x 23"h



#777  
SOFA TABLE  
42"w x 15"d x 30"h



#776  
END TABLE  
18"w x 22"d x 23"h



#773  
COFFEE TABLE  
42"w x 19"d x 19"h\*





#753  
**SWIVEL GLIDER**  
31"w x 32"d x 42"h\*



#754  
**GLIDING OTTOMAN**  
23"w x 16"d x 15"h\*



#762  
**RECLINER LOVESEAT**  
82"w x 35"d x 42"h\*



#713  
**COFFEE TABLE WITH LIFT TOP**  
44"w x 22"d x 19"h (29" raised)

*Breezy*  
- Point -

\* all seats are approximately 19" high and 20" deep

**MORE IN BREEZY POINT**

Many of the items featured in pages 13 to 23 of this catalog are also available in Breezy Point. Here's just a few of them:

- 761 Recliner
- 765 Swivel Recliner
- 741 Wall Hugger Recliners



#787  
**OTTOMAN**  
23"w x 16"d x 15"h

#784  
**MORRIS CHAIR**  
34"w x 35"d x 37"h\*



#763  
**RECLINER SOFA**  
82"w x 35"d x 42"h\*

\* all seats are approximately 19" high and 20" deep



#786  
SOFA  
85"w x 35"d x 37"h\*



#785  
LOVESEAT  
56"w x 35"d x 37"h\*

Breezy  
- Point -



# QUENTIN

Did the Quentin's style catch you off guard? We think the comfort level will too!

This accent recliner was designed specifically for eye appeal and enhanced comfort.

The French name Quentin is derived from the Latin "quintus" which means "the fifth" an acknowledgment to the metal accent circle, the important fifth component of this design. An air of graceful simplicity surrounds this inviting synergy of handcrafted wood, metal, and fabric.



**#866 Reclining Options:**

Manual (#866-MAN)

Powered (#866-PRW)

*Powered recliner features finger touch controls conveniently concealed in the seat.*



**#866  
RECLINER**

27" w x 38" d x 41" h\*

SHOWN IN:  
Oak wood with Husk Stain  
C2-6 Normal fabric

\*seat is 18" high and 21" deep

# GENERAL WARRANTY AND CARE

**T**he Craftsman Collection warrants to you, the original retail purchaser, ten year protection against manufacturing defects of any wooden components. Defective parts will be repaired or replaced at our discretion.

**W**ood is a natural product, and although we take great care to match grain and colors, some variation may occur.

**W**ith proper care, your furniture will last for years! It's essential to keep it free from dust and body oils. To maintain its pristine condition, gently wipe surfaces with a soft, damp cloth or a high-quality furniture polish. Regular cleaning is key, and remember to avoid silicone-based polishes to ensure the longevity of your pieces!

**N**atural wood will expand and contract with the seasons. This is normal, but it is important to avoid extremes in humidity and temperatures. Avoid having furniture in direct sunlight, close to heat sources, or in extremely damp or dry environments.

**A**ll warranties are void if the recommended care displayed above was not exercised.

## UPHOLSTERY WARRANTY

**Springs and Recliner Mechanisms:** The Craftsman Collection warrants to you, the original retail purchaser, ten year protection against manufacturing defects of the springs and recliner mechanisms. Electrical components of power recliners carry a two year warranty.

**Glider Bearings:** (250 lb. load rating) The Craftsman Collection warrants to you, the original retail purchaser, a three year warranty. If found to be defective, we will replace the defective bearing or bearings.

**Seat and Back Cushions:** The Craftsman Collection warrants to you, the original retail purchaser, ten year protection against manufacturing defects of seat and back cushions. Cushion warranty is for loss of cushion resiliency and not normal flattening and softening of cushions, which is a result of regular use and aging and should not be considered a manufacturing defect. If found defective, cushions will be replaced free of charge. After 2 years we will not be liable for freight.

Cushion softness is significantly affected by the type of fabric or leather that surrounds it. Where applicable, a rotation of the cushion will greatly extend the life of both the cushion and fabric.

**Fabric:** We offer a one year warranty against unusual wear of fabric under normal use and with proper care. This warranty does not cover fading, pilling, or crushing of fibers which can occur with the normal use of some fabrics. All claims within warranty will be submitted for industry testing. We will tender warranty only if it is determined to be an actual fabric defect.

**Genuine Leather:** We offer a three year warranty against unusual wear of leather under normal use and proper care. Genuine leather may be one of the most durable upholstery materials; however, even the best quality leather has flaws and natural markings. Our leather is a protected aniline dyed, top grain leather, making for easy cleanup. (A soft damp cloth is recommended.) However, body oils and dust, etc., will cause this leather to develop a natural patina as it is used, especially in light colored leathers. Slight variations of color, along with the above traits, are characteristic of genuine leathers and distinguish them from synthetic materials. If uniform color and consistent grain are required, a faux leather (vinyl) may be a better choice.

Any of the above warranties are void if it is determined that the furniture was abused, used by pets, or heavily soiled.

# Wood Species

Every piece of furniture is produced with sustainably harvested American hardwoods which means that every tree that is cut down has a replacement sapling that is growing, sequestering carbon, and releasing oxygen. Instead of deforesting, our lumbermen are pruning and refining our wonderful resource, the forest.

**R**ed Oak is a hardwood prized for its hardness. The grain pattern is large and often stains darker showing the character of the oak and making each item a unique masterpiece.

**M**aple has a tight grain pattern and finishes with a smooth, hard surface. It is the ideal choice when pairing with paints or gray based stains.

**C**herry's rich tones give a full bodied look to reddish stains. The grain pattern is similar to maple. Cherry stains often appear deeper and richer as they age.

**Q**uarter-Sawn White Oak can be identified by its unique ray flake grain. To create quarter-sawn wood, the log is first quartered and then cut perpendicular to the growth rings. This results in a very straight, fine-grained surface.

To make the most of that distinction, we use quad-linear posts for the legs of our upholstered mission furniture. Usually, a leg post is created from a 3"x3" board. But with that approach, only two sides of the leg display the uniqueness of the ray flake grain. To overcome this obstacle, we cut four triangular pieces from our quarter-sawn wood, then glue them together, producing a leg of incredible strength, but most importantly, a leg that displays the beauty of the ray flake grain on all four sides.



Quarter-Sawn Log



Quad-Linear Post

## DESIGN GALLERY

select colors and textures to make it truly your own

# Stains

## Oak



## Maple



## Cherry



### A NOTE ABOUT COLORS!

Due to limitations in imaging and printing, some colors may not match exactly to what is shown here. For best results, make color choices from dealers sample blocks.

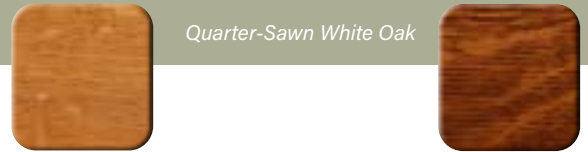

Autumn Wheat 421

Michael's OCS-113

Imagine The Possibilities!

Mix and match stain and paint colors to create your unique feel.

# Designer Finishes



# Paint Colors



### A NOTE ABOUT COLORS!

Due to limitations in imaging and printing, some colors may not match exactly to what is shown here. For best results, make color choices from dealers sample blocks.

# Fabric Options

Many upholstery options are available. Ask us about our collection of 300+ choices of upholstery including Fabrics, Micro-fibers, Faux Leather and Genuine Leather by Heartland Fabrics. We also use Greenhouse Fabrics, Buckeye Fabrics, Sunbrella Fabrics, or COM (customer's own material).

## Popular Leather Choices



Pecan



Rum



Texas



Tapestry



Cigar



Mahogany



Grey



Mushroom



Fossil



Jean



Black



Whiskey



Oxblood



Tumbleweed



Luna



Vanilla



Night Sky

# DESIGN GALLERY

select colors and textures to make it truly your own

# Hardware

## Black



## Antique Brass & Oil Rubbed Bronze



### A NOTE ABOUT COLORS:

Due to limitations in imaging and printing, some colors may not match exactly to what is shown here. For best results, make color choices from dealers sample blocks.



## Pewter & Gun Metal



D-529-B



D550-B



29379-AS



D527-B



D551-B



K804-B



53701WN



K801-B



29370AS

## Silver



D521-SN



K790-SN

## Wooden



K55

Standard on the  
Shaker Collection.  
-used for drawers and doors

# DESIGN GALLERY

select colors and textures to make it truly your own

